

## Device manual

### Power controllers in the POWERCONTACT family

**HP3211 Universal power controller module (10% Offset)**  
**Phase angle control, pulse package, soft start, 50/60 Hz**  
**Analog, digital and serial control signals**

Function, Start-Up and Troubleshooting







Created: Mederer V1.0 (24.07.2003)  
 Revised: Mederer V1.0 to V1.2 withdrawn  
 DieLe V2.0 (27.03.2016) Complete reworking in conformance with CE

## 1 Legal notes

### 1.1 Warning information concept

This manual contains information which must be observed for your personal safety and for the avoidance of material damages. Such information concerning your personal safety is labelled using a warning triangle, information on material damages alone is given without a warning triangle.

Warning information is presented below in a decreasing order of the hazard level.

	<b>HAZARD</b> means that death or serious bodily injuries <b>will</b> occur if the appropriate precautionary measures are not taken.
	<b>WARNING</b> means that death or serious bodily injuries <b>could</b> occur if the appropriate precautionary measures are not taken.
	<b>CAUTION</b> means that minor bodily injuries could occur if the appropriate precautionary measures are not taken.
	<b>ATTENTION</b> means that material damages could occur if the appropriate precautionary measures are not taken.

If more than one hazard level is included within the warning information, the highest level will be applied.

In a warning if personal hazards are highlighted with a warning triangle, then the same warning information could also include a warning on material damages.

### 1.2 Copyright

Copyright © Systemtechnik LEBER GmbH 2003-2016 All Rights Reserved.

This document shall not be exploited, reproduced or communicated to third parties in whole or part except where express authorization has been granted. Infringements shall render the party responsible liable for damages. All rights reserved, in particular with respect to the granting of patents or registration of utility models.

### 1.3 Liability exclusion

We have checked the content of this printed work for agreement with the hardware described. Despite this, deviations cannot be completely excluded which means that we cannot accept liability for complete agreement. The information in this printed work is, however, regularly checked and the necessary corrections are included in subsequent editions. We would be very thankful to receive suggestions for improvement. We reserve the right to make technical changes without prior notice.

## 1.4 Important!

	<p><b>Warning</b> Read the documentation carefully. Warranty claims will not be entertained in respect of damage resulting from a failure to observe the documentation. We shall accept no liability for secondary damages resulting from such non-observance.</p>
---	--

## 1.5 Safety instructions

	<p><b>HAZARD</b> The module or subassembly may only be handled by persons who are capable of recognising dangers of contact and are able to take the right safety precautions. Danger of contact exists wherever voltages greater than 60 VDC or 42 VAC can occur.</p>
	<p>In accordance with Standard EN 60204-1 (VDE 0113) it is imperative that some tests, which you must implement and document, are carried out when electrical equipment is completely connected to the machine.</p>
	<p>Pursuant to the current German accident prevention regulations (UVV) DGUV-V3 (prev. BGV-A3), the tests must be carried out and documented by a qualified electrician.</p>
	<p>Deviating but similar regulations apply in other countries.</p>

Systemtechnik LEBER products may only be used for the applications specified in the manual and in any other associated technical documentation. If third-party products and components are used, these must be recommended or approved by LEBER. Proper transport, proper storage, setting up, assembly, installation, commissioning, operation and maintenance are a requirement for faultless and safe operation of the products. The permissible environmental conditions must be observed. Information provided in the associated documentation must be observed.

## 1.6 Incorrect use

	<p><b>HAZARD</b> The module or the subassembly is not intended for the commercial market or the "end user". Direct or indirect export to the USA or Canada is not permitted without explicit approval.</p>
---	--

## 1.7 Intended use

	<p><b>WARNING</b></p> <ul style="list-style-type: none"><li>• The module or the subassembly is exclusively intended for use in industrial machines or equipment. It is imperative that the use of this module or this subassembly is preceded by a pre-engineering in which the statutory mandatory provisions for the relevant employers' liability insurance association or organisations is drawn up for the machine or equipment to be created, and which therefore forms the basis for all technical solutions.</li><li>• This module or this subassembly is not a device in the sense of the Equipment Safety Law but a component which can be linked together with other components to form equipment or a machine. The relevant statutory provisions for proper use of the machine or equipment apply.</li><li>• The planning, installation, commissioning, testing, maintenance and disassembly of the machine or equipment may only be carried out by qualified electricians or appropriately trained personnel. Corresponding information must be included in the user information for the relevant machine or equipment and clearly labelled as such.</li><li>• If the machine or equipment is for use abroad the standards applying there must be observed.</li><li>• If the machine or equipment is to be exported to the USA or Canada, you must apply for permission covering our modules or subassemblies.</li></ul>
---	---

## Contents

1	Legal notes .....	2
1.1	Warning information concept .....	2
1.2	Copyright .....	2
1.3	Liability exclusion .....	2
1.4	Important! .....	3
1.5	Safety instructions .....	3
1.6	Incorrect use .....	3
1.7	Intended use .....	4
2	Description of the module .....	6
2.1	Application .....	6
2.2	Implementation .....	6
2.3	Operating principle .....	6
2.3.1	<i>Phase angle control</i> .....	7
2.3.2	<i>Pulsation ratio</i> .....	8
2.3.3	<i>Zero-point switch with error detection</i> .....	8
2.4	Technical data .....	9
2.5	Jumper .....	10
2.6	Serial protocol .....	11
2.7	Terminal assignment .....	13
2.8	Order designation .....	13
2.9	Drawings, diagrams .....	14
3	Assembly .....	17
3.1	Control line connections .....	17
3.2	Module installation .....	19
3.3	Connecting the load lines .....	21
3.4	Load break detection .....	22
4	Commissioning .....	23
5	Operation .....	24
6	Maintenance and Service .....	25
7	Miscellaneous .....	26
8	Troubleshooting .....	29
9	CE Declaration of Conformity .....	31

## 2 Description of the module

### 2.1 Application

The module represents a universally controllable power controller.

Either a control voltage (0 VDC up to 10 VDC) or a serial protocol can be used for activation, and then either a proportional phase angle control or a pulsation ratio from power supply full wave rectifiers with or without ramp (soft start) can be provided. The different functions are configurable via jumper.

The module is typically screwed in piggyback on top of a Solid-State Relay (SSR), mounted together on a suitable heat sink, and can be clipped to a 35mm DIN rail by a clip.

### 2.2 Implementation

The module is based on an instantaneously-switching semiconductor power controller housed in the industry-proven "Series 1" housing, which means that it is structurally identical with many Solid-State Relays (*Figure 5 - Design example HP4075-3211*). It has 2 screw terminals X1 for the load switch and a plug connection X2 for the control lines and auxiliary voltage.

The module is fitted with six jumpers which can be used to set functionalities. The seventh jumper can be used to switch the relay output (error message relay) from NC (nomally closed) to NO (normally open). 4 LEDs which display the operating condition and status of the module are fitted. The LEDs can also be read when the cover cap is fitted.

The module must be sufficiently cooled for normal operation. For this purpose, it is screwed to a heat sink suitable for the rated power and must be fitted in the control cabinet so that the convection air or priority-controlled cooling air does not exceed the maximum surrounding temperature.

The module functions are specified using a programmable controller and six jumpers.

### 2.3 Operating principle

The module is provided with auxiliary power, triggered and monitored via plug X2. Screw terminals X1.1 and X1.2 represent the load switch and are switched in the load circuit in series.

The module controls the load with a semiconductor switch and is therefore largely wear-free and insensitive to a wide range of environmental influences.

The module monitors itself and the load circuit continuously. If there is a fault, the red LED triggers an alarm, the alarm output switches over to LOW and the potential-free contact switches over to OPEN.

LEDs show the module operating status.

	<p><b>CAUTION</b></p> <p>Activation of the module via analog setpoint always requires a separate digital enable signal. If the parent control unit (PLC) causes a STOP, the analogue outputs normally remain at a standstill. The module only switches off because the digital enable goes away.</p> <p>There is no enable signal when transmitting the setpoint using a serial telegram. We therefore recommend that you control the 24 V auxiliary supply via a digital output. If the parent control unit goes to STOP, the 24 V supply to the module goes away and the load is switched off immediately. Otherwise the module would remain at the last setpoint.</p>
---	--

	<p><b>CAUTION</b></p> <p>The module must be sufficiently cooled for normal operation. There is no monitoring for overtemperature.</p>
---	---

Instead of this we recommend that you monitor the cabinet temperature in at least one or several zones and initiate suitable short-term measures if this is exceeded, for example:

- proper shutdown of the equipment or machine
- running to a safety position
- notification and a brief, restricted running for machine operator's decision etc.

The load fuse as shown in *Figure 7 - Typical connection 230V / 400V* does not require separate monitoring. If this fuse blows the module will detect this and report a malfunction.

The three most important functions in the universal module are described below.

	<p><b>ATTENTION</b></p> <p>Any changes to jumper settings, and therefore the function, only take effect after the module has been restarted. This means: - disconnect plug connection X2, wait briefly and reconnect.</p>
---	---

### 2.3.1 Phase angle control

If jumper JP6 is open, the load is provided via phase angle control. This operating mode is used mostly for lamps and spotlights.

The setpoint can be 0% to 100%. The controller always fires 10% as a minimum setpoint (Offset). Changes to the setpoint are started up with a ramp depending on the settings at jumpers J1 and J2. The following ramp speeds can be set:

0s / 0.5s / 1s / 2.5s (total runtime for 0% to 100%).

The setpoint can be transmitted analog or serial.

If the setpoint is analog, a control voltage of 0 up to 10 VDC is applied to Input 1 (X2.4). Additionally, an enable must be applied at Input 2 (X2.5) as a digital 24 VDC signal.

The ramp starts once the enable signal has been applied.

If the enable or setpoint goes away the load is switched off immediately - a soft stop does not take place.

If activation is made using a serial telegram via inputs DATA (X2.4) and CLOCK (X2.5) there are restrictions on the selection of ramp speeds. Ramp speeds between 0s and 1s can be selected with jumper JP1. Jumper JP2 is required for selection of the maximum setpoint 100/255 (64h/FFh). For details see telegram description.

### 2.3.2 Pulsation ratio

If Jumper JP6 is inserted the load is supplied via a pulsation ratio (Bursts) with mains full waves. This operating mode is usually applied to ceramics radiators or heating circuits with longer thermal inertia.

The setpoint can be between 0% and 100%, and is interpreted as a ratio to 100 or to 256 depending on the setting of Jumper 2. If Jumper JP2 is open, values of 0/256 up to 255/256 (continuous ON) are possible, and if jumper JP2 is inserted the values are 0/100 to 99/100 (continuous ON). The controller always fires 10% as a minimum setpoint (Offset).

A setpoint is always reduced as far as possible. For example, if setpoint 50% is to be applied, e.g. 50/100, then this is reduced to a value of 1/2. This means: 1 of 2 full waves will be switched on.

If Jumper JP1 is inserted and if the last setpoint was 0, a ramp will run in phase angle control from 0 to 100% in approximately 1s for preheating the load. This is of advantage for loads with high cold inrush currents. The cold load does not have a full wave applied immediately, but is slowly preheated.

The setpoint can be transmitted analog or serial.

If the setpoint is analog, a control voltage of 0 up to 10 VDC is applied to Input 1 (X2.4). Additionally, an enable must be applied at Input 2 (X2.5) as a digital 24 VDC signal.

If activation is made with a serial telegram via both DATA (X2.4) and CLOCK (X2.5) inputs, the maximum setpoint will be switched over between 100 or 255 (64h or FFh) using Jumper JP2. For details see telegram description.

The switching behaviour during pulse package control is shown in *Figure 9 - Diagram of Pulse Ratio with soft start*.

### 2.3.3 Zero-point switch with error detection

If Jumpers JP5 and JP6 are inserted, the module behaves as a zero point-switching Solid-State Relay with error detection. Activation takes place as a digital signal via Input 1 (X2.4). This functionality is lost as soon as voltage is applied to Input 2 (X2.5).

The switching behaviour is shown in *Figure 10 - Diagram of load voltage with zero-point switch with monitoring*.

**Note!** We recommend that Input 2 is permanently connected to ground.

**Note!** As stated above, the module only works properly when connected with instantaneously-switching Solid-State Relays. If, despite this, zero point-switching Solid-State Relays are used, a conflict between the SSR and the module's zero-point window will occur.



## 2.4 Technical data

Auxiliary voltage (X2.1/2 and X2.3)	24VDC +/- 20%, Residual ripple less than 1Vpp typ. 25mA at operating state OK typ. 17mA at operating state ERROR
Input 1 (analog) (X2.4)	0.0 – 10V, typ. 2.5mA (-2.0 to 16.0V for 10 seconds)
Input 1 (digital) (X2.4)	24VDC, typ. 2.5mA (-2 to 5VDC = OFF, 8 to 32V = ON)
Input 2 (digital) (X2.5)	24VDC, typ. 2.5mA (-2 to 5VDC = OFF, 8 to 32V = ON)
Alarm output (X2.6)	24VDC, max 100mA HIGH = OK LOW = fault
Alarm output (X2.7 and X2.8)	Potential-free contact Jumper 7 Setting 1-2 = NC Jumper 7 Setting 2-3 = NO
Mains voltage	180VAC to 480VAC
Mains frequency	50 Hz +/-3 Hz or 60Hz +/-3 Hz
Nominal current	1.5 to 50A for PR4850-HP32xx- (see Derating) 1.5 to 90A for PR4890-HP32xx- (see Derating)
Ambient temperature	0°C to 60°C operation (see Derating) -20°C to 80°C storage
Humidity range	non-condensing
Protection Class	IP20 (with cover cap fitted)
Atmosphere	non-corrosive atmosphere
Dust pollution	Pollution level 1 in acc. w. DIN EN 60947-1 If dust pollution levels change, the maintenance and service intervals must be shortened appropriately.
Installation level	maximum altitude 2000 m above sea level
EMC interference output EMC compatibility	The EMC requirements can only be taken from the deployment case. However, we recommend that the control lines are routed as screened in accordance with the relevant recommendations. The use of screened load cables and the use of a DU/DT Choke is recommended for special deployment cases.
Displays	LED 1 green illuminates if setpoint >10% applied LED 2 green illuminates if enable applied LED 3 green illuminates on various functions LED 4 red illuminates if the module detects a fault. Display is delayed OFF by 2 seconds
Screws X1	included
PCB connector X2	8-pole RM 3.5mm
Plug for X2	8-pole screwed connection for cable cross-section 1mm <sup>2</sup> , included
Dimensions, weight (without heat sink)	W x H x D 45mm x 105mm x 42mm 250gr

## 2.5 Jumper

The module functionalities are set using Jumpers (JP1 to JP6). New definitions are only retained after a RESET (remove plug X2, wait 2 seconds and reinsert).

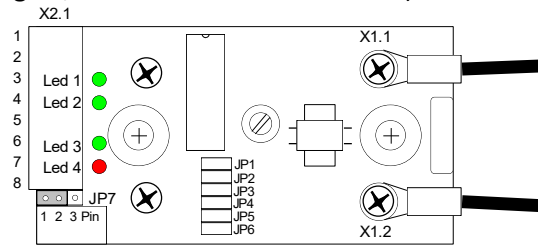

Figure 1 - jumper locations

JP6 = open (Phase angle control)	JP5 = open (analogue setpoint)	JP1/JP2	open/open inserted/open open/inserted inserted/inserted	→ no ramp (0s) → ramp approx. 0.5s → ramp approx. 1s → ramp approx. 2.5s
	JP5 = inserted (serial setpoint)	JP1	open inserted	→ no ramp (0s) → ramp approx. 1s
		JP2	open inserted	→ Setpoint 0 - 255 (00h - FFh) → Setpoint 0 - 100 (00h - 64h)
JP6=inserted (pulse package control unit)	JP5 = open (analogue setpoint)	JP1	open inserted	→ Setpoint accepted directly → Before 1st acceptance of the control value, a ramp will run through in 0.5s phase angle control (preheating)
	JP5 = inserted (serial setpoint)	JP2	open inserted	→ Setpoint 0 - 255 (00h - FFh), analogue 0V - 10V Pulsation ratio 0/256 - 255/256 → Setpoint 0 - 100 (00h - 64h), analogue 0V - 10V Pulsation ratio 0/101 - 100/101
		JP3/JP4	open/open inserted/open open/inserted inserted/inserted	→ automatic mains frequency detection → mains frequency 50Hz fixed → mains frequency 60Hz fixed → automatic mains frequency detection
		JP7	1-2 inserted 2-3 inserted	→ Error - output NC (normally closed) → Error - output NO (normally open)

## 2.6 Serial protocol

If jumper JP5 is inserted, the setpoint must be transmitted as a serial telegram. Simple digital 24VDC transistor outputs from a control unit (PLC) are used as data and clock lines. The data line is connected to Input 1 (X2.4), the clock to Input 2 (X2.5). We recommend the use of a programmable logic control (PLC) or a PC. The setpoint is transmitted using the TransDil protocol. A free driver is available for the S5 and S7 SIEMENS PLC families.

The user must write his own drivers for other control units and PCs. The protocol handling is described as follows:

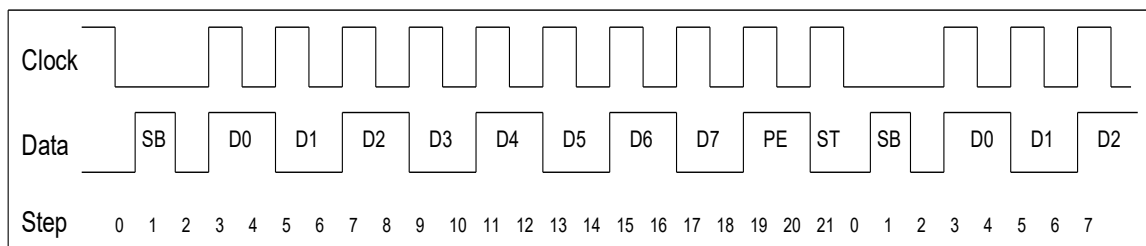

SB=start bit / D0-D7 data bit / PE=parity / ST=stop bit

**Figure 2 - serial telegram setup of TransDil protocol**

Transmission of one setpoint is made within 22 steps.

**STEP 0 to 2 describes the start bit**

- In STEP 0 CLOCK and DATA are set to LOW
- In STEP 1 DATA is set to HIGH.
- In STEP 2 DATA is reset to LOW.

**STEP 3 and 4 describe the lowest-value bit D0 of the setpoint**

- In STEP 3 CLOCK is set to HIGH and DATA is set to LOW or HIGH depending on the status of the lowest-value bit.
- In STEP 4 DATA remains unchanged and CLOCK changes to LOW.
- In STEP 5 and 6 these are repeated for the next data bit D1.
- In STEP 7 to 18 these are repeated for the remaining bits of the 8-bit long setpoint D2-D7.

**STEP 19 and 20 describe the telegram parity bit (PE)**

- In the odd STEP, CLOCK is set to HIGH and DATA is set to LOW or HIGH depending on the calculated parity.

Parity becomes HIGH if the sum of all HIGHS of the setpoint is an even number.

It is then supplemented to ODD.

Example: 5Ah has 4 HIGH bits and therefore leads to a parity HIGH.

Example: 00h has 0 HIGH bits and therefore leads to a parity HIGH.

Example: 13h has 3 HIGH bits and therefore leads to a parity LOW.

- In the even STEP, DATA remains as is and CLOCK changes to LOW.

**STEP 21 and 0 describe the STOP bit of the setpoint**

- In STEP 21, CLOCK is set to HIGH and DATA is set to LOW.
- The STEP counter is then set to 0 and a new transmission starts.

**In general, the rules are:**

- DATA is read during every negative cycle change.
- Transmission of a byte begins with the LSB.
- PARITY is supplemented to ODD.
- At least one STOP bit must occur after a PARITY.
- If the CLOCK is LOW and the DATA line changes from LOW to HIGH and then back to LOW, a START bit is assumed.
- The length of the telegram is 1 byte of 8 bits.
- The CLOCK rate is not critical, but the length of each STEP must exceed 22msec.
- The telegram can be kept as long as required in STEP 0.
- However, we recommend that the telegram is continuously repeated. The Hamming distance with only one PARITY bit is 0. This means that 2 wrong bits in the telegram are not always properly detected.
- Some variants of the HP32xx do have an internal telegram monitoring. These watch that the telegram is proper transferred at least every 2 seconds. If the time is longer, they assume that the PLC has stopped and switch the load OFF immediately.

**Note!**

No special serial hardware is required for the PLC or the PC. The CLOCK and DATA signals are created using normal 24 VDC digital outputs.

Each module requires its own data line and a common output for CLOCK which is routed in parallel to all modules.

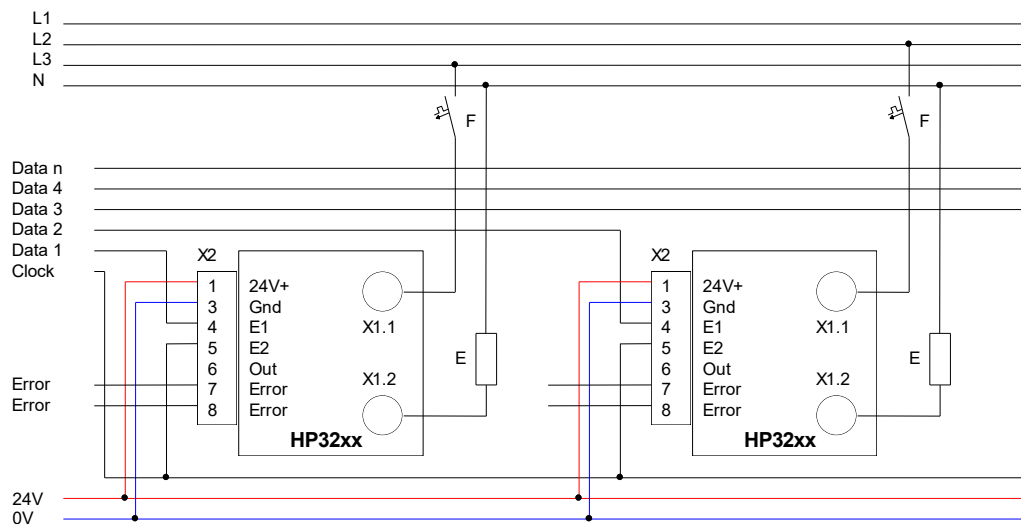

**Figure 3 - control using TransDil protocol**

## 2.7 Terminal assignment

X2.1	24VDC auxiliary voltage	internally connected with X2.2
X2.2	24VDC auxiliary voltage	internally connected with X2.1
X2.3	Reference ground	
X2.4	Input 1 SETPOINT (0V to 10VDC) or	DATA (24VDC - digital)
X2.5	Input 2 ENABLE (24VDC - digital) or	CLOCK (24VDC - digital)
X2.6	Output	24VDC
X2.7, X2.8	ERROR	potential-free contact NC max 60V, max 20mA
X1.1	Load switch	no polarity
X1.2	Load switch	no polarity

## 2.8 Order designation

Order designation	U <sub>nom</sub>	I <sub>nom</sub>	Dimensions (W*H*D), weight
HP2305-3211	230 VAC	5 A	45mm*55mm*93mm, 215g
HP4005-3211	400 VAC	5 A	45mm*55mm*93mm, 215g
HP4805-3211	480 VAC	5 A	45mm*55mm*93mm, 215g
HP2316-3211	230 VAC	16 A	45mm*145mm*93mm, 515g
HP4016-3211	400 VAC	16 A	45mm*145mm*93mm, 515g
HP4816-3211	480 VAC	16 A	45mm*145mm*93mm, 515g
HP2330-3211	230 VAC	30 A	45mm*145mm*93mm, 515g
HP4030-3211	400 VAC	30 A	45mm*145mm*93mm, 515g
HP4830-3211	480 VAC	30 A	45mm*145mm*93mm, 515g
HP2350-3211	230 VAC	50 A	72mm*154mm*95mm, 960g
HP4050-3211	400 VAC	50 A	72mm*154mm*95mm, 960g
HP4850-3211	480 VAC	50 A	72mm*154mm*95mm, 960g
HP2375-3211	230 VAC	75 A	72mm*154mm*95mm, 960g
HP4075-3211	400 VAC	75 A	72mm*154mm*95mm, 960g
HP4875-3211	480 VAC	75 A	72mm*154mm*95mm, 960g

## 2.9 Drawings, diagrams

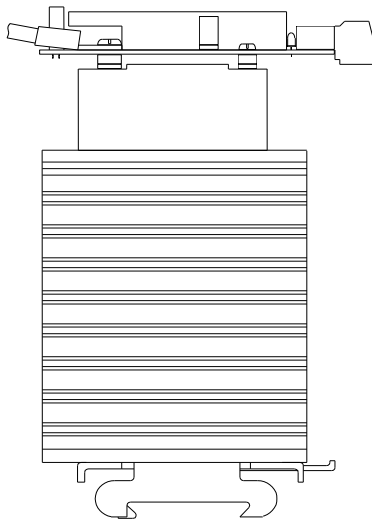

Figure 5 - Design example HP4075-3211

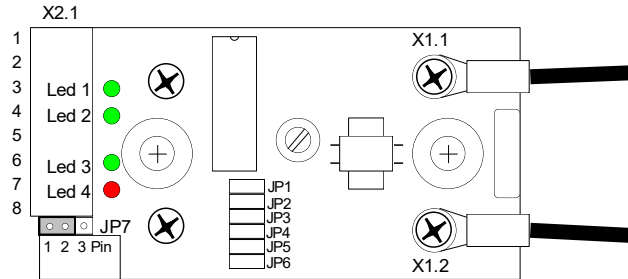

Figure 4 - Location of plugs, jumpers and LEDs

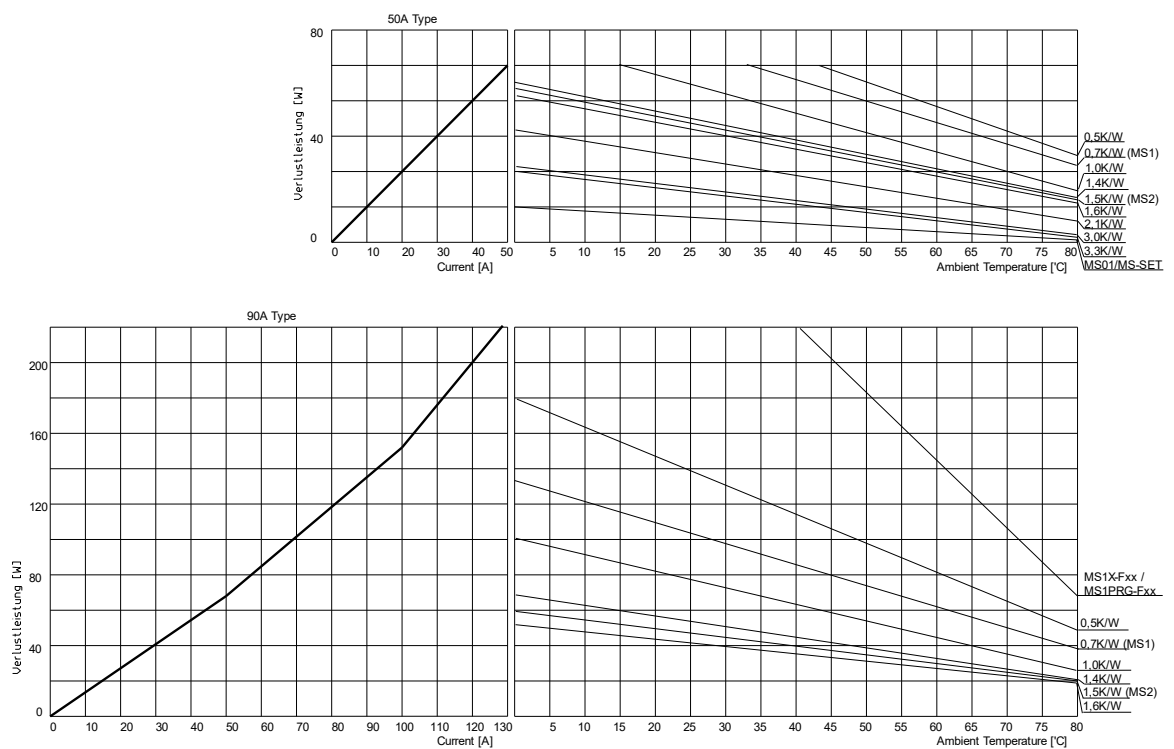
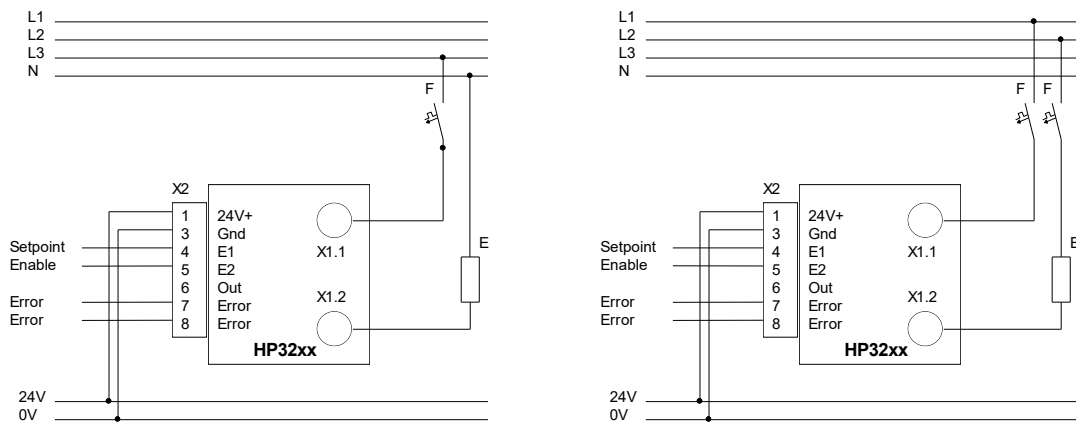
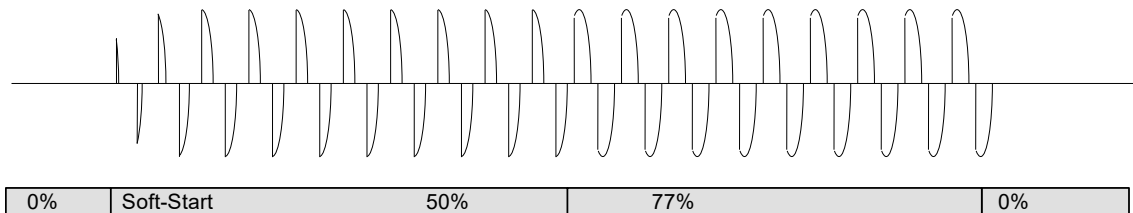

Figure 6 - Derating curves



**Figure 7 - Typical connection 230V / 400V**



**Figure 8 - Diagram of phase angle control with ramp on cold start**

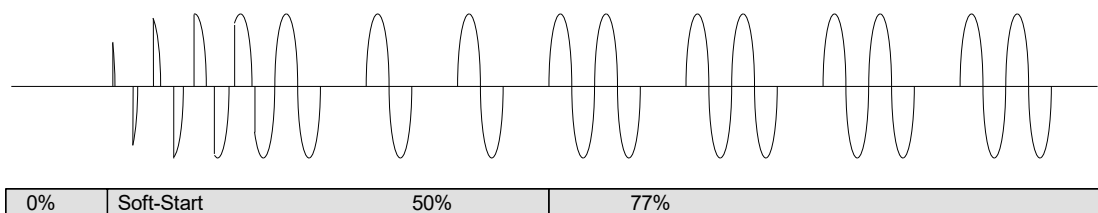

**Figure 9 - Diagram of Pulse Ratio with soft start**

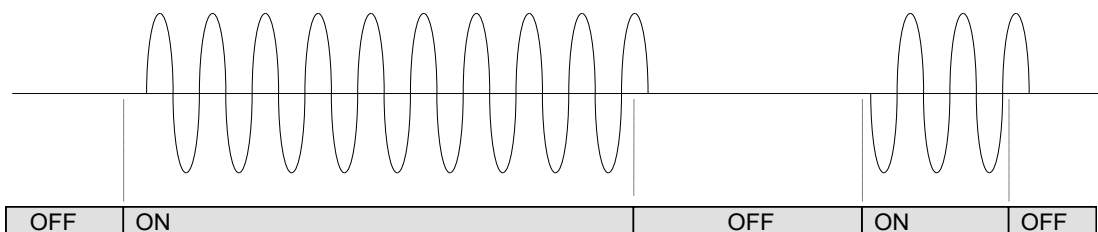

**Figure 10 - Diagram of load voltage with zero-point switch with monitoring**

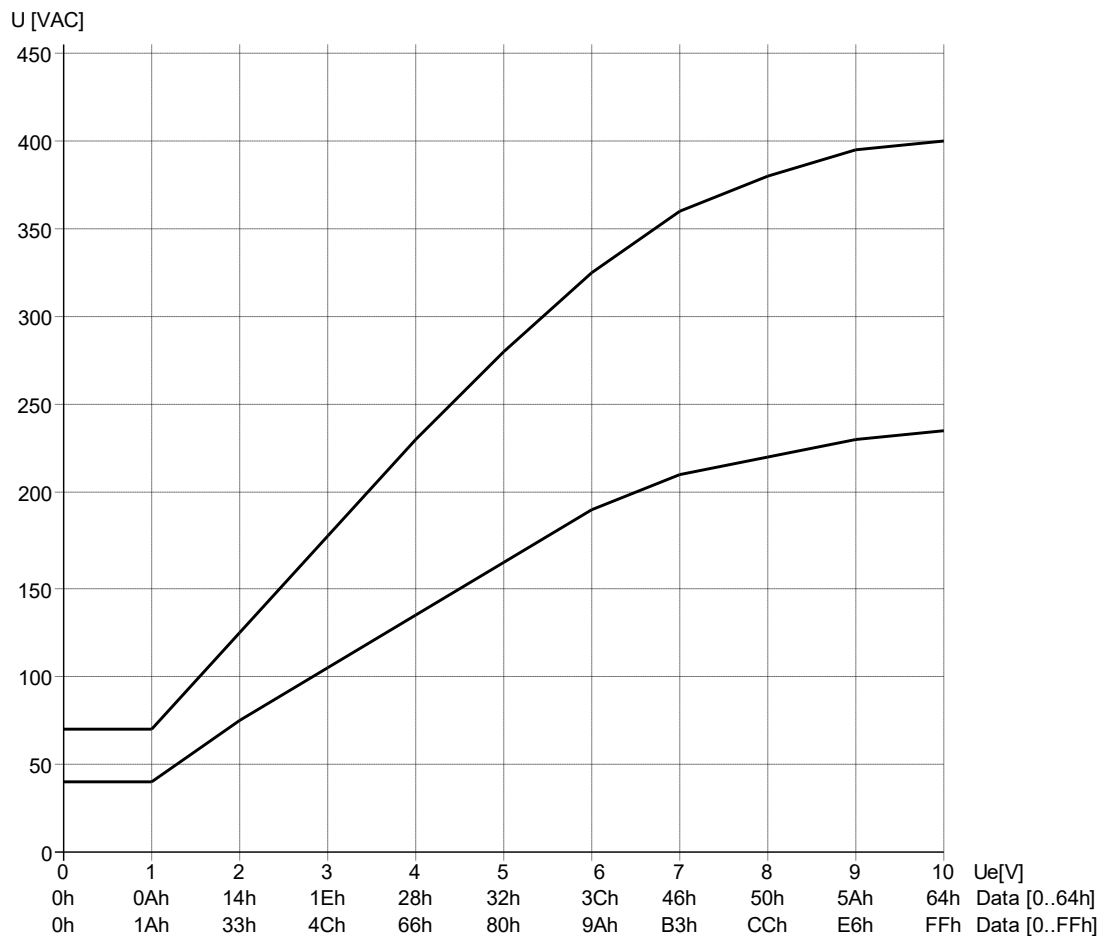

**Figure 11 - Effective load voltage via control voltage**



### 3 Assembly

#### 3.1 Control line connections

The auxiliary voltage and the control signals are applied to terminal connector X2. The module has a common reference point both for auxiliary voltage and for control signals. For this reason, we recommend "low-impedance" cabling as shown in Fig. 10.

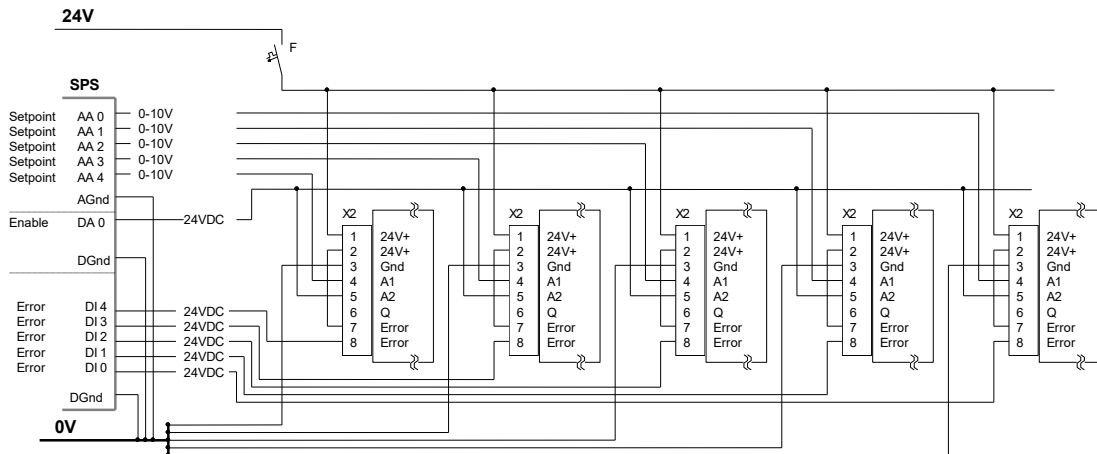

Figure 12 - Design with individual alarm evaluation

In this example, the ERROR line is routed separately to the PLC for each module and evaluated there. Jumper JP7 should be inserted as NC!

One side of the potential-free contact can be connected directly to 24 V - see bridge X2.2 to X2.7

As shown in *Figure 12 - Design with individual alarm evaluation* the power cable carrying the 24 V DC auxiliary voltage must be fused with 2 A fuses as a wiring protection.

We recommend that the control lines are screened.

If there is only one module, or only a few modules with short cables, you can work using a common 0 V auxiliary voltage line as shown in the following example.

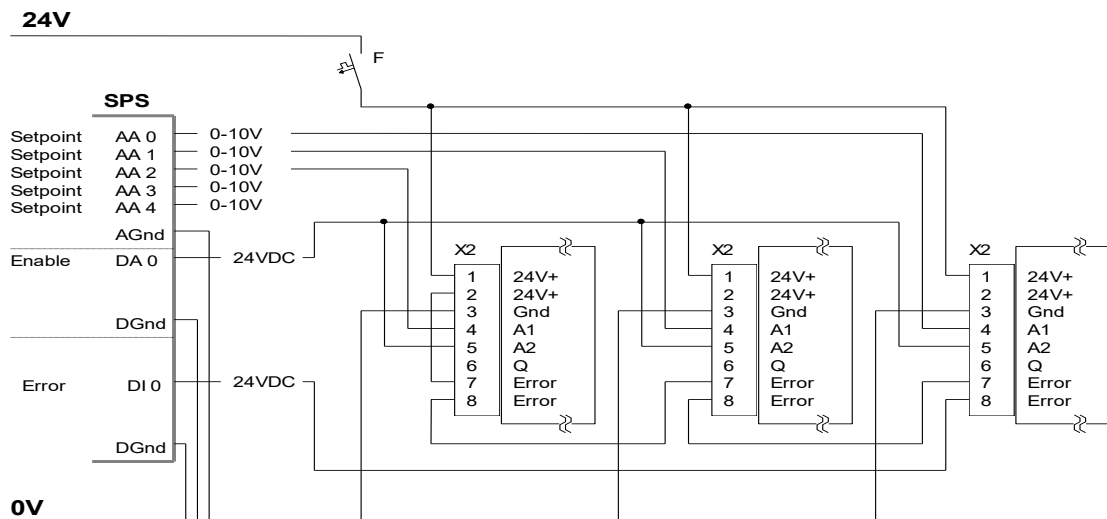

**Figure 13 - Design with daisy chain alarm evaluation**

As shown in *Figure 13 - Design with daisy chain alarm evaluation*, a common evaluation of the alarm allows further saving on cabling costs. Jumper JP7 should also be inserted as an NC for this arrangement as well.

### 3.2 Module installation

Suitable cooling must be provided depending on the rated voltage used to drive the module. *Figure 6 - Derating curves* is used as selection criteria.

The diagram should be explained using the following example:

Rated current: 48A

Ambient temperature: 58°C

First of all, the necessary cooling performance will be determined for a 50A PR4850 Solid-State Relay.

Start vertically at the 48 A point up to the power loss characteristic curve. There, the horizontally line continues to the right.

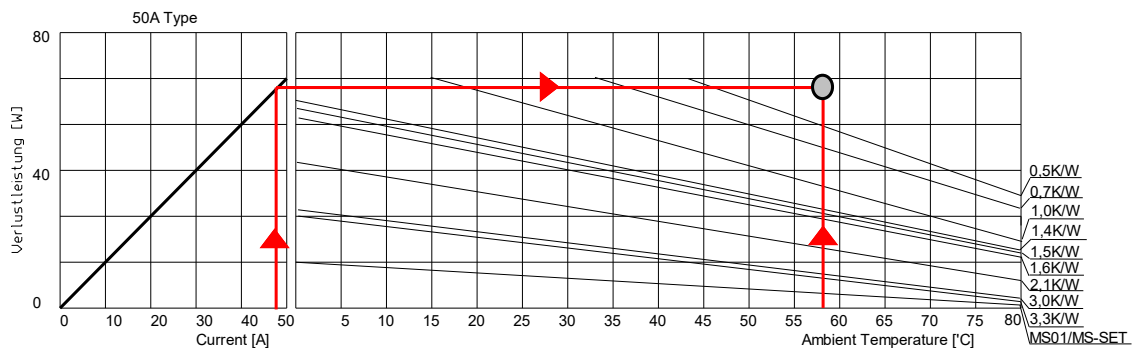

**Figure 14 - Example of cooling requirements PR4850**

Then start at 58°C ambient temperature and look for the horizontal line crossing point.

According to the example in *Figure 14 - Example of cooling requirements PR4850* the intersection point of the power loss and the surrounding temperature determines the minimum cooling power. All Heatsinks whose characteristic curves run to the right of the intersection point can be used.

As can be seen from the diagram, there is no Heatsink available as standard which can provide this cooling performance using convection cooling.

It is therefore necessary to use the more powerful PR4890 module. Its cooling power is calculated as follows:

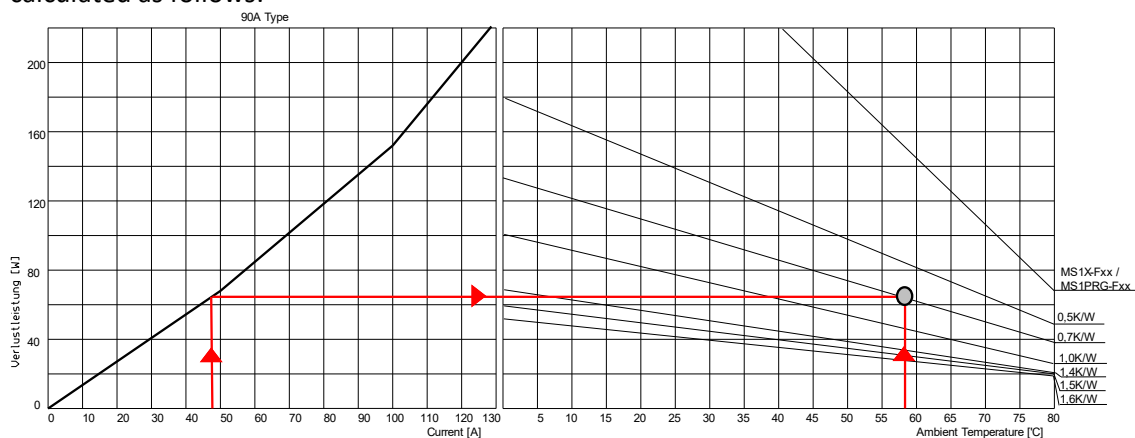



**Figure 15 - Example of cooling requirements PR4890**

According to the example in *Figure 15 - Example of cooling requirements PR4890*, the intersection point cuts through the 0.7 K/W characteristic curve here.

This means that all Heatsinks with a cooling performance of 0.7K/W or better are suitable for this use. According to this, an MS1 Heatsink would be most suitable from the Heatsink range. The module is fixed to the Heatsink using DIN 7985 M4x10 screws. A continuous thin layer of P12 heat conducting paste containing silicon is applied to the underside of the module to improve thermal conductivity. The screw must be fitted using an externally-toothed serrated washer to DIN 67982 provide screw locking and to compensate thermal movement.

**Note!**

	<b>ATTENTION</b> The screws must be tightened to such a torque that the serrated washer is squashed completely flat.
---	---

	<b>ATTENTION</b> Before fitting the module onto the Heatsink you must check that the module assembly surface and the heat sink assembly surface are completely flat and free of dust. The contact surface should be thinly coated with heat conducting paste.
---	---

	<b>ATTENTION</b> The heat sink with the fitted module is to be fitted inside the control cabinet so that the cooling ribs are vertical, e.g. using a DIN 35mm DIN rail. Convection air must be able to flow through the cooling ribs without any obstruction.
---	--

	<b>ATTENTION</b> If several modules must be mounted next to each other in one control cabinet, it must be ensured that there is a space of at least 10 mm between neighbour modules. Otherwise, part of the surface is lost as a cooling surface.
---	--

Ready-for-use complete sets (modules mounted on heat sinks with clips for fixing to a 35mm DIN rail) are available ex-works. We would be happy to advise you.

### 3.3 Connecting the load lines

The load cables are provided with DIN 46234 or DIN 46237 eyelets, and are fixed to load connection X1 using the screws provided. When doing so, pay special attention to the fact that the temperatures in the control cabinet can be higher than 55°C when selecting and dimensioning the cable.

Another decisive factor is that load connection X1 can reach temperatures of up to 100°C in full load operation. If general high temperature-resistant cable are not used, we recommend routing the first beginning of the cable as an "air loop" before routing the rest through the cable duct to provide additional cooling.

	<p><b>CAUTION</b></p> <p>Solid-State Relays are naturally wear-free electronic switches which produce considerably more power loss due to their working principles than conventional mechanical relays.</p> <p>This power loss is dissipated into the surroundings using a heat sink.</p> <p>Even if properly dimensioned, a Solid-State Relay can reach internal temperatures of up to 100°C. This temperature can expand as far as the connections.</p> <p>The cabinet manufacturer must be aware of this fact and must plan an "air loop" for the load cable so that the beginning of the cable is in free air for at least 10 cm before it runs into a cable duct.</p>
---	--

	<p><b>CAUTION</b></p> <p>A control cabinet and its internal construction must be overall protected against electrical direct contact.</p> <p>A Solid-State Relay with a cover cap in place completely fulfils this requirement.</p> <p>However, whether a cable which has been laid as an air loop and which is being operated outside its specification in the area around the air loop fulfils these requirement is open to question. The cable insulation could become softened in the area of the air loop and present a hazard even to trained personnel.</p> <p>We therefore recommend that this area be completely barricaded off by use of a transparent Polycarbonate shield.</p>
---	--

### 3.4 Load break detection

You must pay special attention to cable routing between the relay and the load. In the case of typical cabling depicted in Figure 16 - Capacitance of cables routed in parallellaying, the cables in parallel results in a parasitic capacitance which becomes larger with increasing cable length. If, for example, the load disappears due to a break in very long cable lengths, it means that sufficient power flows through this capacitance to feign a full functioning load.

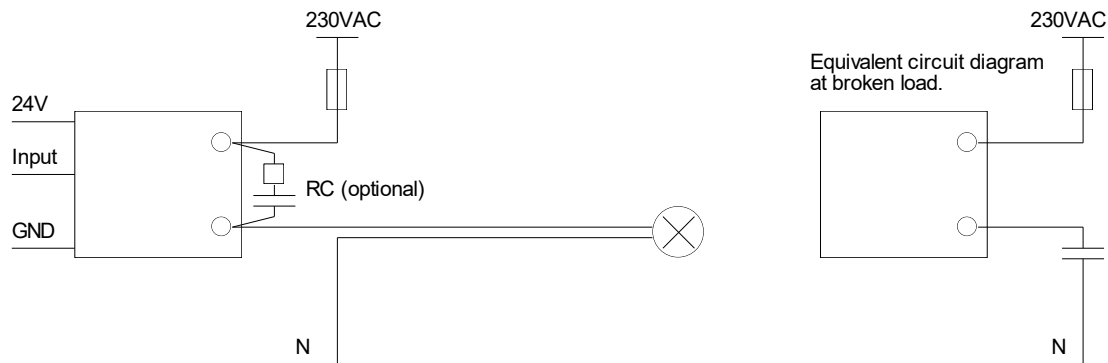

**Figure 16 - Capacitance of cables routed in parallel**

For this reason, the cable lengths stated in the following table should not be exceeded. When estimating the cable lengths, the table assumes the worst case which could occur if cables are routed through the cable duct with the smallest-possible spacing. In practical terms such unfavourably low spacings do not occur. You should not assume that such extreme values will occur except for cases in which the connection between the relay and the load is made using a multicore cable.

Multicore cables have a capacitance of between 1.0 and 1.4 nF for every 10 m of cable length.

If an RC Snubber of 0.1 $\mu$ F and 47 Ohm is laid across the Solid-State Relay, the module is able to detect all errors with certain restrictions. Please refer to the following table for details.

	Cable length	Capacitance	Note
230V	up to 80 metres	8nF	Module detects all errors
230V	up to 300 metres	30nF	Module does not detect load breakage. All other errors such as fuse blow and power breakdown will be detected.
400V	up to 50 metres	5nF	Module detects all errors
400V	up to 100 metres	10nF	Module does not detect load breakage. All other errors such as fuse blow and power breakdown will be detected.
230V with RC 0.1/47	up to 200 metres	20nF	If load at 0% is triggered, the module will detect all errors. It will only recognise fuse blows and mains breakdowns for intermediate values.
400V with RC 0.1/47	up to 100 metres	10nF	If load at 0% is triggered, the module will detect all errors. It will only recognise fuse blows and mains breakdowns for intermediate values.

## 4 Commissioning

If an arrangement consisting of our power controllers together with other components from other manufacturers is fitted and is to be switched on for the first time, a few pre-checks must be carried out.

- Check the planning and dimensioning of the components used. This especially applies to:
  - Rated current supply
  - Rated load values
  - Dimensioning of load cable
  - Rated value of fuses
  - Rated value of power controllers used
  - Power controllers and loads are correctly allocated. Loads of different sizes are not mixed up.
  - Load circuits are correctly wired. A load circuit can be wired between phase and N or between 2 different phases.
- Disconnect all data connections between the equipment or the machine and the outside world.
- You should first put the equipment SELV circuit into operation.
- Once the SELV circuit is running, disconnect all plugs on the central control unit which are connected to the power controllers.
- After this, start operating each load circuit.

**WARNING**

Hazardous voltages and SELV get very close within the power controller. Although the technical conditions for "safe separation" are completely fulfilled, this "safe separation" can sometimes be bridged, for example by residual wire snippets. Work extremely carefully and cleanly when carrying out electrical wiring. There is a hazard to personnel if this "safe separation" should be bridged in any manner. This especially applies to indirectly participating personnel who, for example, are working on other equipment which is connected via an industrial bus - these personnel are endangered just as much as personnel working directly on the equipment or the machine.

**WARNING**

Incorrect wiring or incorrect dimensioning normally results in overcurrent or overvoltage. Overcurrent or overvoltage always leads to component overload. Overloaded components can suddenly burst into flame or explode. You should therefore protect yourself with personal safety equipment.

- Once all fuses have been inserted, carry out a test in conformance with Regulation DGUV-V3 of the German Statutory Accident Insurance (DGUV).
- You can now reconnect all the data connections.

## 5 Operation

The module has no operating buttons or knobs. There is no need to perform any activations on the module during operation.

Four LEDs are integrated in the module for diagnostic purposes.

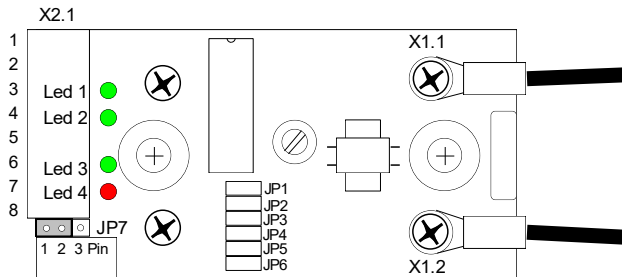

**Figure 17 - Meaning of LEDs**

### **LED 1 - SETPOINT**

Illuminates if setpoint >10%.

With analog control > 1.0V

With serial control > 0Ah (10..100) or >1Ah (26..255)

### **LED 2 - ENABLE**

Illuminates if an enable signal occurs at connection X1.5 during analogue control, the cycle signal is shown if control is being carried out via a series protocol.

### **LED 3 - MONITOR**

Illuminates depending on jumper assignment, e.g. for the time during which the module is switched.

### **LED 4 – ERROR / DISORDER**

Illuminates when the module detects a malfunction. Once a malfunction has been eliminated the display goes out with an OFF delay of 2 seconds.

### **Please note**

Once 24 V has been applied, the module carries out a frequency check and then selects either 50 Hz or 60 Hz operation. If no mains power is being applied the module does not start regular operation, which means that neither of the two green LEDs illuminate irrespective of how the inputs are allocated.

If the jumpers are set to the AUTOMATIC DETECTION 50 Hz/60 Hz setting, the decision as to whether to operate with 50 Hz or 60 Hz is made with the 4th half-cycle of the starting mains sine wave. This means that the unit ignore any general distortions that occur during the first two half-cycles after mains restart.



---

## 6 Maintenance and Service

The module has been constructed using the most modern semiconductor technology available and is therefore maintenance-free. The installation location must be checked for dust at regular intervals and blown off the dust if necessary. The maintenance intervals must be adapted to dust loading.

**WARNING**

Before carrying out any service or maintenance work the control cabinet, the machine or the equipment must be electrical switched off, checked and secured. Maintenance and service work may only be undertaken by a qualified electrician. Binding details are specified in DGUV-V3 of the German Statutory Accident Insurance (DGUV).

No service work is intended for the module. Checks can only be carried out by the manufacturer.

## 7 Miscellaneous

	<p><b>HAZARD</b> <b>The module is not intended for use by the "end user". It must be safely protected from access of layperson.</b></p> <p>We recommend that the module is safely installed in a lockable control cabinet. Access to this control cabinet must be strictly regulated.</p> <p>No operating elements are fitted to this module. The LEDs are only used to display operating states and it only makes sense to skilled personnel.</p>
---	--

	<p><b>HAZARD</b></p> <p>A Solid-State Relay is not a disconnect switch in the sense of "safe separation". Although the Solid-State Relay has not switched, residual voltages which could be hazardous to personnel can still occur at the load connections.</p> <p>For this reason, the 5 safety rules for use by trained electricians must be observed before carrying out any work on the equipment:</p> <ul style="list-style-type: none"><li>- Disconnect mains</li><li>- Prevent reconnection</li><li>- Test for absence of harmful voltages</li><li>- Ground and short circuit</li><li>- Cover or close of nearby live parts</li></ul>
---	--

	<p><b>HAZARD</b></p> <p>All power supplies, load connections and data lines must be disconnected before carrying out any decommission work on the equipment or to the control cabinet. This work may only be carried out by trained, qualified personnel.</p> <p>Our modules should not be disposed of in household waste. They must be recycled to a proper electronic waste recycler - observe the WEEE specifications.</p>
---	---

	<p><b>WARNING</b></p> <p>Control and load lines must be routed in separate cable ducts.</p>
---	---

	<p><b>WARNING</b></p> <p>The cables must be connected to the module in such a way that the cover cap can be safely put in place afterwards.</p>
---	---

	<p><b>WARNING</b></p> <p>For reasons of the high-temperature loads we recommend that the entire wiring in a field is covered by using a polycarbonate panel to ensure that any possible overheated "air loops" are safely protected against contact as required by Regulation DGUV-V3 of the German Statutory Accident Insurance (DGUV).</p>
---	--

	<p><b>WARNING</b></p> <p>Loads and their cabling, which are to be controlled using such modules, must be protected in conformance with the relevant regulations and must be provided with automatic switch-off. In the simplest case, this can be provided using one or more fuses. Cables, terminals and plugs used must be dimensioned to suit the load and the installation situation. The fuses used must guarantee at least cable protection. Fuses protect the equipment both against short-circuit and overload. While almost all fuses have similar blow-out characteristics in cases of short-circuit, they react very differently under overload conditions.</p> <p>If it is the case that the planner of a control cabinet wishes to achieve special fusing of the Solid-State Relay, the manufacturer can provide suitable integral melt fuses for the Solid-State Relay and can provide recommendations.</p> <p>We recommend the use of a D/D0 fuse system or the use of B circuit breakers to provide a more simple and cost-effective fusing system.</p>
---	---

	<p><b>WARNING</b></p> <p>Hazardous voltages and SELV get very close within the power controller. Although the technical conditions for "safe separation" are completely fulfilled, this "safe separation" can sometimes be bridged during service work, for example by residual wire snippets.</p> <p>Work extremely carefully and cleanly while any service work.</p> <p>There is a hazard to personnel if this "safe separation" should be bridged in any manner. This especially applies to indirectly participating personnel who, for example, are working on other equipment which is connected via an industrial bus - these personnel are endangered just as much as personnel working directly on the equipment or the machine.</p>
---	--

	<p><b>WARNING</b></p> <p>Incorrect wiring or incorrect dimensioning normally results in overcurrent or overvoltage.</p> <p>Overcurrent or overvoltage always leads to component overload. Overloaded components can suddenly burst into flame or explode. You should therefore protect yourself with personal safety equipment.</p>
---	---

- The load fuse as shown in *Figure 7 - Typical connection 230V / 400V* does not require separate monitoring. If this fuse blows out, the module will detect this and report a malfunction.
- Insofar as a transformer with predominantly ohmic secondary load is used as a load, the transformer should never be operated idle on the secondary side. We recommend always ensuring a base current of 5%. The minimum current varies very strongly depending on manufacturer and transformer construction type.
- Any changes to jumper settings, and therefore the function, only take effect after the module has been restarted. This means: Disconnect the plug connection X2, wait briefly and reinsert.
- The module has been constructed using the most modern semiconductor technology available and is therefore wear-free. However, we recommend that you check the dust loading at regular intervals and, if necessary, blow off the dust in the module with oil-free compressed air (max. 1 bar) when it is isolated from the power supply. These intervals should be adapted if the dust loading changes.
- There are no special regulations relating to storage of the modules as long as the permissible surrounding conditions are observed. The only condition is that the relative humidity should never be higher than 30%. Open module connections are affected if the humidity is too high whereas enclosed (fitted) connections are gas tight and are therefore unaffected by higher humidity.
- No special specifications are provided for transport. Each module should be professionally packed and should comply with standard transport guidelines issued by freight carriers. Seawater-proof packaging is recommended for overseas transport.
- No special handling guidelines are provided. In general, all persons handling the module should protect themselves against ESD (electrostatic discharge) in the same manner as they use for all electrical and electronic components.
- The module does not contain any substances which are listed in connection with the RoHS Directives.
- No service work is intended for the module. Checks can only be carried out by the manufacturer.

## 8 Troubleshooting

Fault	Cause
<p>The module is not working - the red LED is permanently illuminated.</p>	<p>The module is detecting a fault continuously. You must ensure that the module is not activated in order to narrow down the possible faults.</p> <ol style="list-style-type: none"> <li>1. Measure terminal voltages at X1.1 and X1.2. These voltages must be at the same levels as the load voltage. If not, check the load circuits (consumers, fusing, terminals etc.) with its wiring. The min voltage should always be higher than 180V<sub>AC</sub>/300V<sub>AC</sub>. Undervoltage detection is activated below this level.</li> <li>2. Measure the leakage current in the load circuit through the module. It should always be close to 0.0 A<sub>AC</sub> (lower than 5mA) in the switched-off state.</li> <li>3. Measure the leakage current at both ends of the load current circuit. This should have the same level at both ends. If not, leakage current is being discharged somewhere.</li> </ol>
<p>The module is not working - the red LED is not illuminated.</p>	<p>The module may not be working.</p> <ol style="list-style-type: none"> <li>1. Check the auxiliary voltage. It must be within the specified range.</li> <li>2. Disconnect the plug and re-insert after a wait of around 2 seconds. After reinserting the plug the red LED should illuminate for approx. 0.5 seconds. If not, there is an internal fault.</li> </ol> <p>The module is actually working</p> <ol style="list-style-type: none"> <li>1. Check to ensure that an enable (at E2) greater than 12.00 V<sub>DC</sub> (max. 32.0 V<sub>DC</sub>) is being applied. Check that the green status LED is illuminating.</li> <li>2. Check that a medium to high SETPOINT is being applied. Lower SETPOINTS cause smaller phase angle controls due to the system which, in turn, only show no effect or only very low effect in the load. For example, lamps only start to illuminate above around 25% power. When measuring the actual load voltage please note that "usual" digital multimeters (DMM) can only correctly measure sinusoidal wave forms. You must use an RMS-capable DMM or a moving-iron instrument to correctly measure a phase angle controlled load voltage.</li> </ol>
<p>The module is working - the red LED illuminates occasionally.</p>	<p>The module is detecting occasional faults in the load circuit. Such faults can have a range of causes:</p> <ol style="list-style-type: none"> <li>1. Strong mains interference influences entire half-cycles so that half-cycles which have already been initiated stops.</li> <li>2. Idle current compensation equipment can also cause such strong interference that the module is hampered in its function.</li> <li>3. Failure of half-cycles from the EVU or substation.</li> <li>4. The rated voltage is at the bottom end of the tolerance range.</li> <li>5. Highly-frequented transients cause du/dt overhead ignition.</li> <li>6. The module has an internal fault and does not trigger.</li> </ol>

<b>Fault</b>	<b>Cause</b>
The module is working - the red LED illuminates permanently after a certain time.	The module is only detecting a fault after a certain time: <ol style="list-style-type: none"> <li>1. if the module becomes too hot, the undervoltage limit slips away upwards. Although the load voltage is below the lowest tolerance it is still possible that an undervoltage alarm is triggered.</li> </ol>
The module is working - however, it gets too hot.	The module is not being cooled sufficiently. <ol style="list-style-type: none"> <li>1. Check to ensure that the temperature of the air underneath the Heatsink is not higher than intended according to your calculations.</li> <li>2. Check that the cooling ribs are free and clean.</li> <li>3. Check to ensure that the module is firmly and completely evenly fitted to the heat sink and that heat conducting paste has been applied.</li> <li>4. Check to ensure that the load current is not higher than intended according to your calculations. When measuring the current load current please note that "usual" digital multimeters (DMM) can only correctly measure sinusoidal wave forms. You must use an RMS-capable DMM or a moving-iron instrument to correctly measure a phase angle controlled load voltage.</li> </ol>

## 9 CE Declaration of Conformity

Wir/We/Nous

Systemtechnik LEBER GmbH & Co. KG  
Haimendorfer Str. 52  
DE-90571 Schwaig

**Erklären in alleiniger Verantwortung, dass das Produkt**  
Declare under our sole responsibility that the products  
Déclarons sous notre seule responsabilité, que les produits

**Halbleiterschütz**  
Semiconductor Contacor  
Contacteurs Statique

# HP3211

**für verschiedene Spannungen (<1000V) und Ströme**  
for different voltages (<1000V) and currents  
pour divers tensions (<1000V) et courants

**mit folgenden Europäischen Richtlinien übereinstimmen:**  
are in conformity with the following directives:  
Répondent aux directives suivantes

**Niederspannungsrichtlinie Nr.: 2014/35/EU**  
Low Voltage Directive No.:2014/35/EU  
Directive Basse Tension N°: 2014/35/EU

**EMV Richtlinie Nr.: 2014/30/EU**  
EMC Directive No.: 2014/30/EU  
Directive CEM N°: 2014/30/EU

**Änderung**

Revision  
Révision

2016-April-04



















Schwaig, 2016-April-08

Ort und Datum der Ausstellung  
Place and date of issue  
Lieu et date de l'édition

**Dies wird nachgewiesen durch die Einhaltung folgender Standarden**  
This is documented by the accordance with the following standards  
Justifié par le respect des standardes suivantes

**DIN EN 60947-1: 2015-09**  
**DIN EN 60947-4-3: 2015-04**  
**DIN EN 62314:2007-04**



	Activation analogue 0 to 10VDC
	Activation digital 0/24VDC
	Activation line current 4 to 20mA
	Activation with serial telegram - TransDil procedure
	Industrial bus system
	Offset typ. 10%
	Operating mode phase angle control 0 to 100% each half-cycle
	Operating mode pulsation package control 0 to 100% full cycle
	Operation with soft start - range of RAM times configurable
	Operating mode zero-point switch
	Operating mode 90° maximum switch
	Automatic detection 50Hz or 60Hz
	Operating mode voltage regulation of load 0 to 100%
	Operating mode current regulation of load 0 to 100%
	Continuous monitoring of load circuit
	Additional mains synchronisation Suitable for inductive or capacitive loads
	Special start-up types for transformers
	Special loading functions for capacitance banks

Systemtechnik LEBER GmbH & Co. KG  
Haimendorfer Str. 52  
D-90571 Schwaig / Germany  
Phone +49 911 215372-0  
Fax +49 911 215372-99  
www.powercontact.de  
info@powercontact.de